



NOLSEN HP-B-SS-100V2
primary side / grundierungskreis / primer oldal

Installation guide
Installationsanleitung
Összeszerelési útmutató



[EN] The co-founder of Nolsen brand is Cool4U Systems Ltd., which has achieved many awards since established in 2001, moreover, the company is exclusive distributor of the Gree air-conditioners and heat pumps' in Hungary.

The other co-founder of Nolsen is Easykit Ltd., which deals with planning and distributing of building engineering systems. Their main goal is to ensure a permanent high quality, price-value ratio and excellent service.

The Nolsen heat centers, together with their accessories, contain all the elements that are essential for heat pump heating of a residential house. In order to facilitate the installation process, our unit comes pre-assembled to the customer. The compact heating center is an excellent choice both for heating modernization and for the construction of a new heat pump system, as well as for those who are new to the implementation of heat pump systems.

[DE] Der Mitbegründer der Marke Nolsen, die Cool4U Systems Kft., die seit ihrer Gründung im Jahr 2001 eine Reihe von Auszeichnungen erhalten hat, ist auch der exklusive ungarische Vertreter von Gree-Klimaanlagen und Wärmepumpen.

Der andere Mitbegründer von Nolsen ist die Easykit Kft., die Haustechniksysteme entwickelt und vertreibt. Das Hauptziel ist es, eine gleichbleibend hohe Qualität, ein gutes Preis-Leistungs-Verhältnis und einen ausgezeichneten Service zu gewährleisten.

Die Nolsen-Wärmezentralen enthalten zusammen mit ihren Zusatzgeräten alle Elemente, die für die Wärmepumpenheizung eines Einfamilienhauses unerlässlich sind. Um die Installation zu erleichtern, werden unsere Geräte vormontiert an den Kunden geliefert. Die kompakte Wärmezentrale ist eine ausgezeichnete Wahl sowohl für die Heizungsmodernisierung als auch für die Neuinstallation von Wärmepumpensystemen und für Neueinsteiger in die Wärmepumpentechnik.

[HU] A Nolsen márka társalapítója a Cool4U Systems Kft., mely 2001-es alapítása óta elismerések sorát nyerte el, valamint nevéhez fűződik a Gree légkondicionálók és hőszivattyúk kizárólagos magyarországi vezérképviselete is.

A Nolsen másik társalapítója az Easykit Kft., mely épületgépészeti rendszerek tervezésével és forgalmazásával foglalkozik. Fő célja az állandó magas minőség, ár-érték arány és kiváló szolgáltatás biztosítása.

A Nolsen hőközpontok kiegészítő egységeivel együtt minden olyan elemet tartalmaznak, melyek elengedhetetlenek egy családi ház hőszivattyús fűtéséhez. A telepítési folyamat elősegítése érdekében berendezéseink előszerelve érkeznek a vásárlóhoz. A kompakt hőközpont kiváló választás mind a fűtéskorszerűsítés, mind pedig új hőszivattyús szisztéma kiépítése esetén, valamint azok számára is akik új belépők a hőszivattyús rendszerek kivitelezésében.

[EN] HP-B-SS-100 HEAT CENTER

Size	1030 X 1080 X 620 mm
Shell material	Powder coated steel (0,5 mm)
Tank material thickness	1,2 mm
Buffer volume	100 L
Buffertank material	Stainless steel (SUS304)
Capacity	4-16 kW (heat pump)
Max. pressure, buffer	10 bar
Direct circuit	Yes
Mixed circuit	Yes (optional item, ESBE 5/4" mixing valve)
Microbubble separator	Yes
Magnetic dirt separator	Yes
Outer pipe system	Stainless steel
Accessories	Wall bracket, Rubber feet

[DE] HP-B-SS-100 WÄRMEZENTRALEN

Maße	1030 X 1080 X 620 mm
Mantelung	Pulverbeschichteter Stahl (0,5 mm)
Materialdicke des pufferspeichers	1,2 mm
Volumen des pufferspeichers	100 L
Material des pufferspeichers	Rostfreier Stahl (SUS304)
Empfohlene wärmeleistung	4-16 kW (wärmepumpe)
Max. Betriebsdruck, Pufferspeicher	10 bar
Direkter kreislauf	Ja
Gemischter kreislauf	Ja, als zusätzliche Einheit mit einem ESBE-Mischventil
Mikroblasenabscheider	Ja
Magnetischer schlammabscheider	Ja
Äußeres Rohrsystem	Rostfreier Stahl
Zubehör	Wandhalterung, Gleitfuß aus Kunststoff

[HU] HP-B-SS-100 HŐKÖZPONT

Termék mérete:	1030 X 1080 X 620 mm
Burkolat:	Porfestett acél (0,5 mm)
Lemezvastagság:	1,2 mm
Puffertartály térfogat:	100 L
Puffertartály anyag:	Rozsdamentes acél (SUS304)
Teljesítmény:	4-16 kW (hőszivattyú)
Maximális üzemi nyomás:	10 bar
Direkt kör:	Igen
Kevert kör:	Esbe keverőszeleppel
Mikrobuborék leválasztó:	Igen
Mágneses iszapleválasztó:	Igen
Külső csőrendszer:	Rozsdamentes acél
Tartozékok:	Fali konzol, gumitalp



A1



x2
1/2"



x1
6/4"



x1
90° 1/2"



x1
1/2"

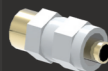

x1
16x2 mm x 1/2"



x2
5/4"



x1
1/2"



x1

A2



x2
5/4"



x2
90° 5/4"



x1
5/4"

A3



x1
5/4"



x2
5/4"



x1
90° 5/4 "



x1
5/4"



x3
5/4"

A4

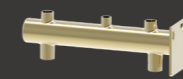

x1



x1
1/2" x 3/4"



x1
3/4"



x1
1/2"



x1
16x2 mm x 3/4"



x1
1/2"



BUFFER TANK
PUFFERSPEICHER
PUFFER TARTÁLY



PRIMARY SIDE
GRUNDIERUNGSKREIS
PRIMER OLDAL



DIRECT CIRCUIT
DIREKTER KREISLAUF
DIREKT KÖR

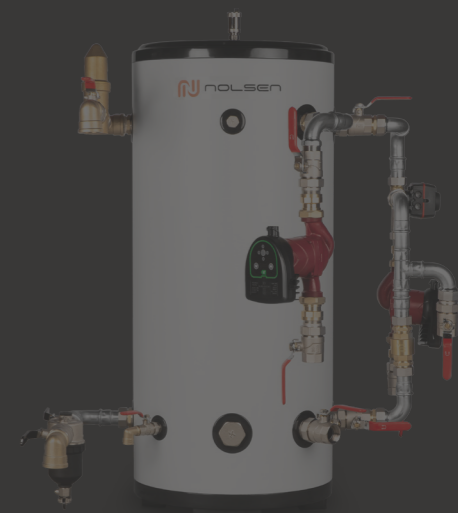

MIXED CIRCUIT
GEMISCHTE KREISEINHEIT
KEVERT KÖR



A1

A2

A3

A4

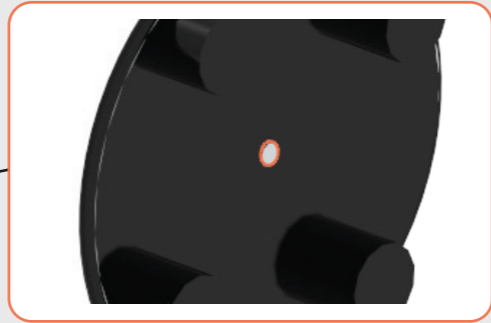
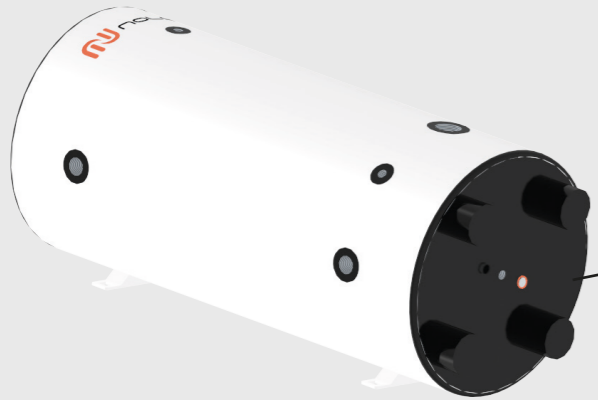
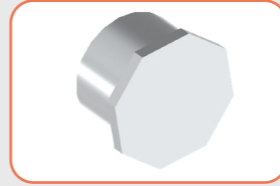
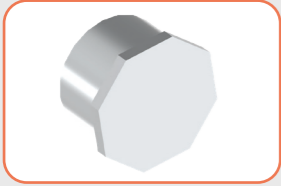

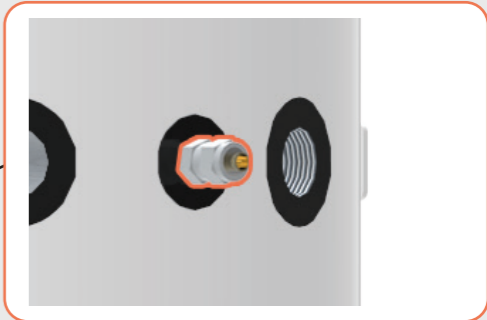
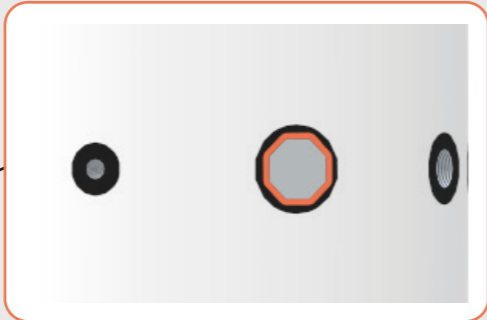
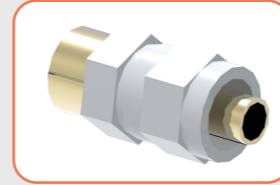
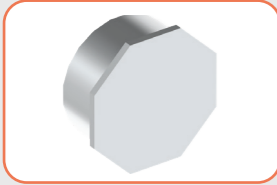

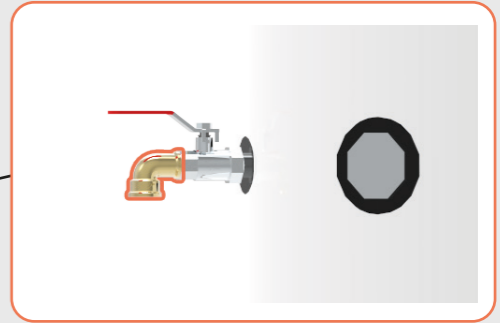
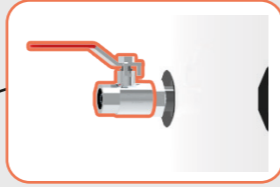
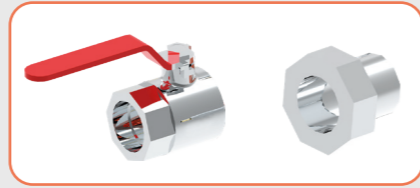
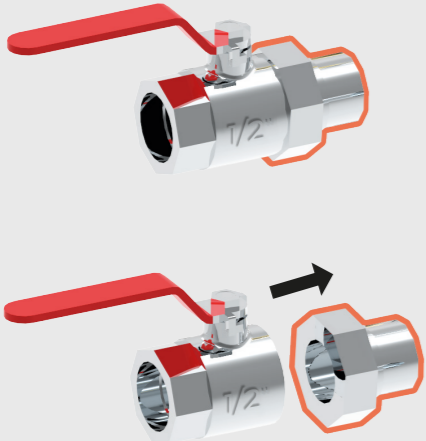
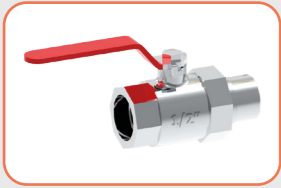

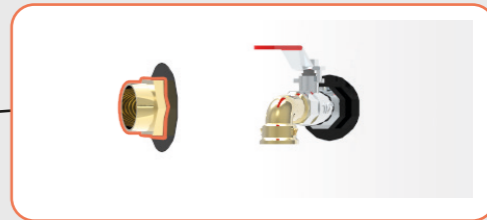
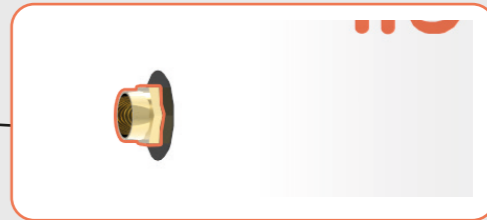
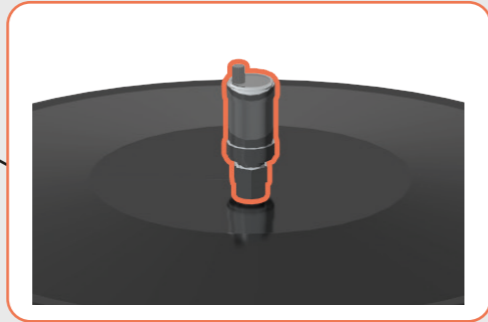
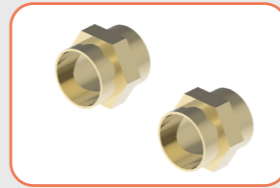



A1 A2 A3 A4

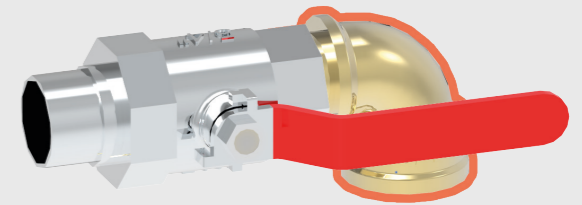
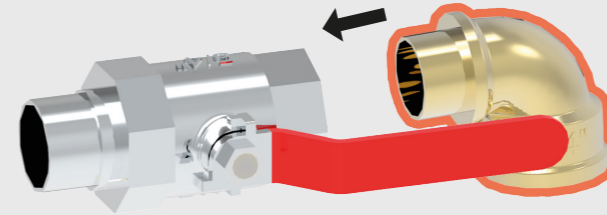
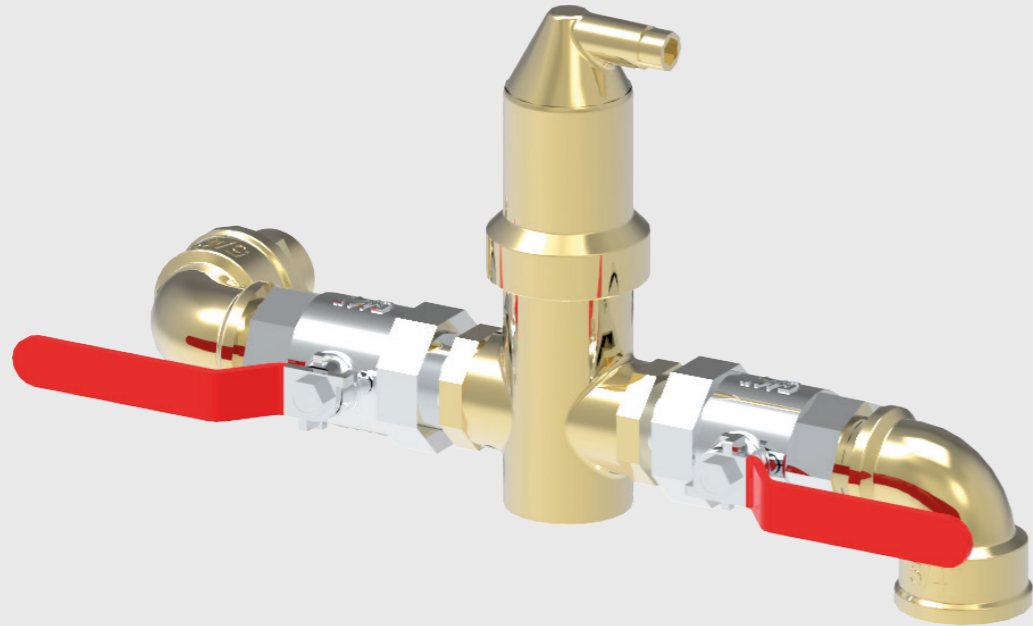

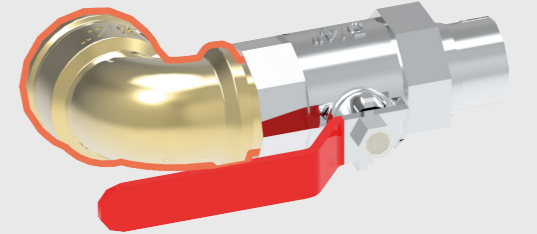
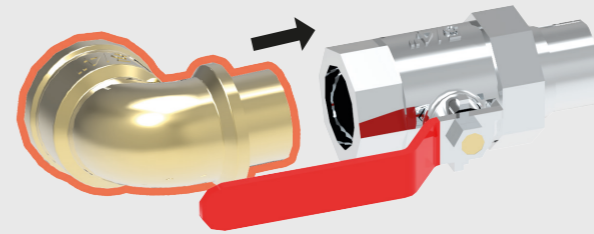
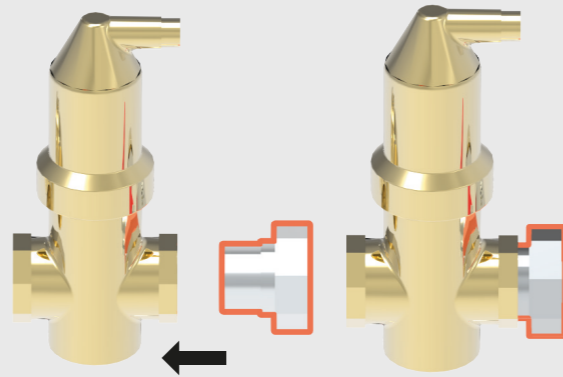
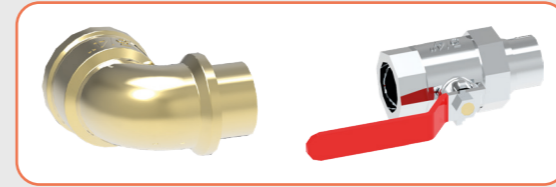
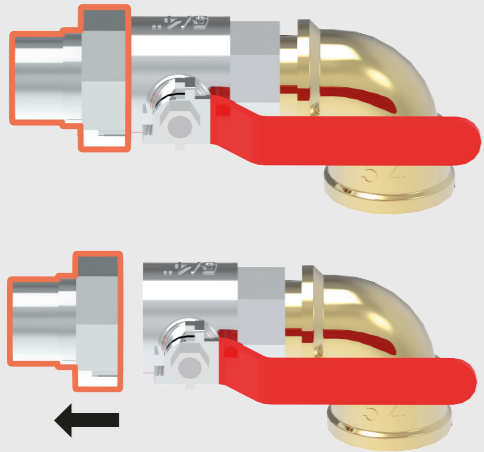

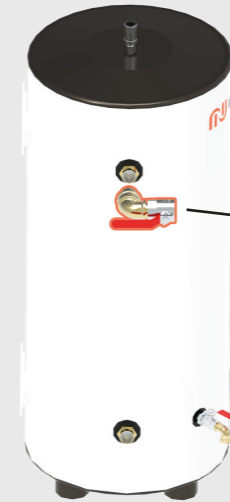
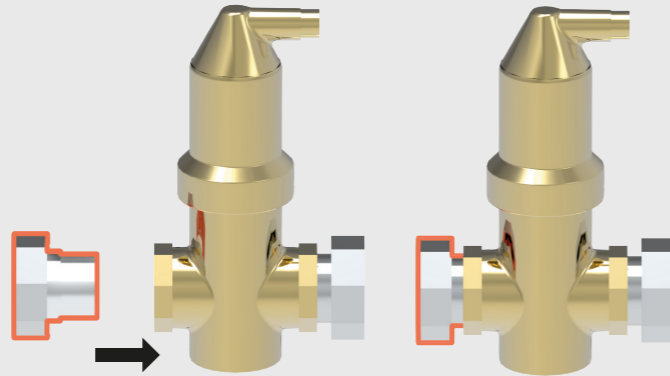
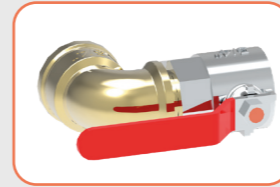
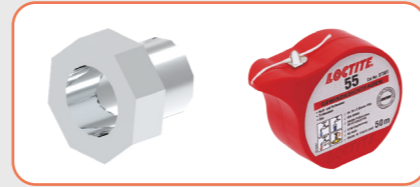
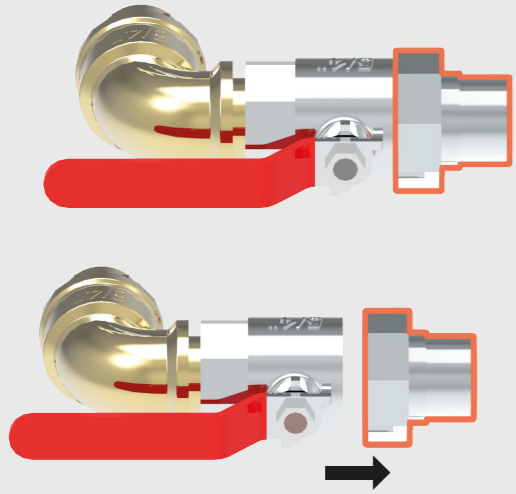

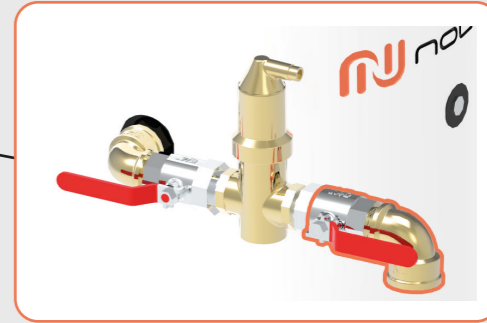
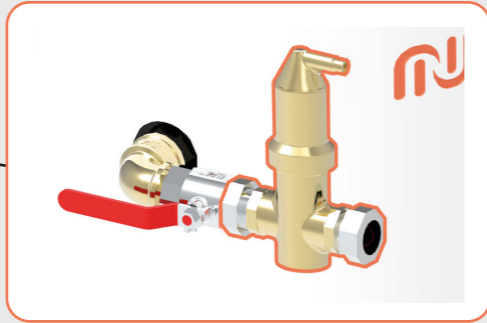
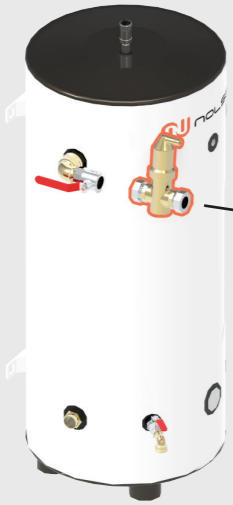

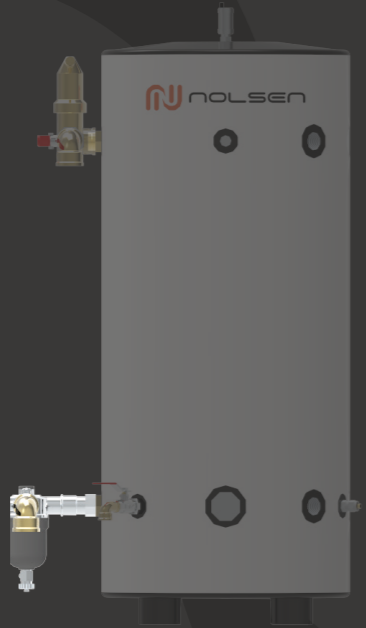

A1 A2 A3 A4

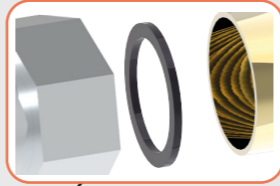
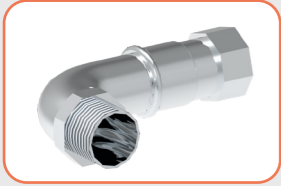

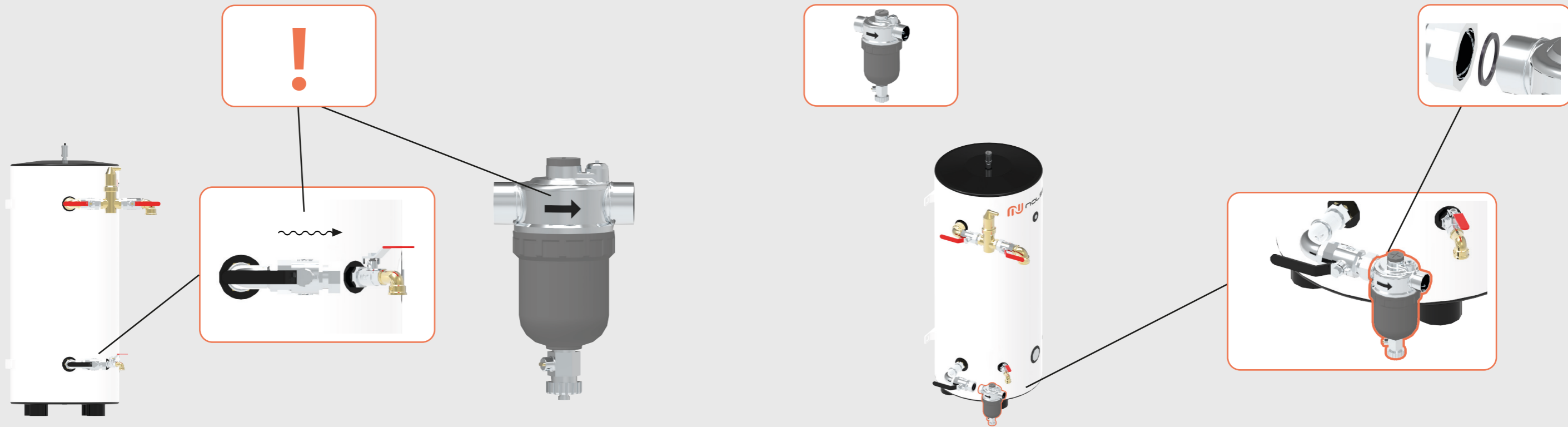

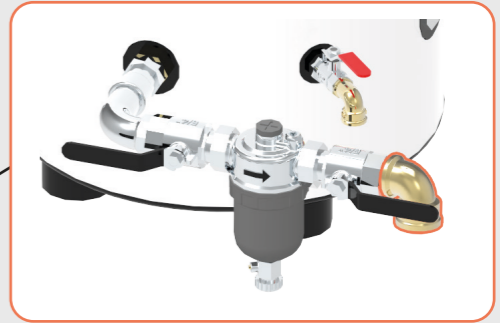
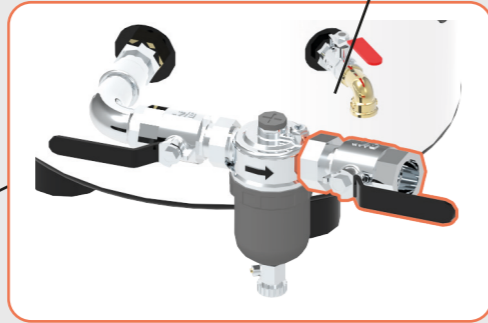
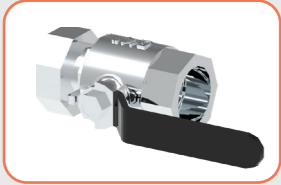

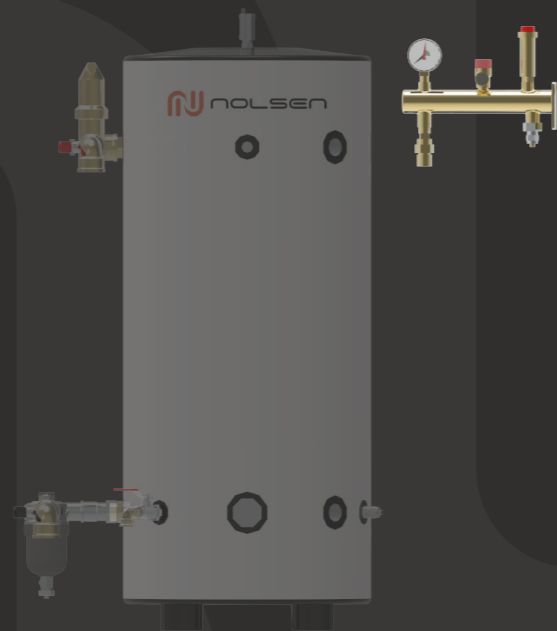

A1 A2 A3 A4

